

Zahnrad/sprocket
 Z=9
 Modul 0,2

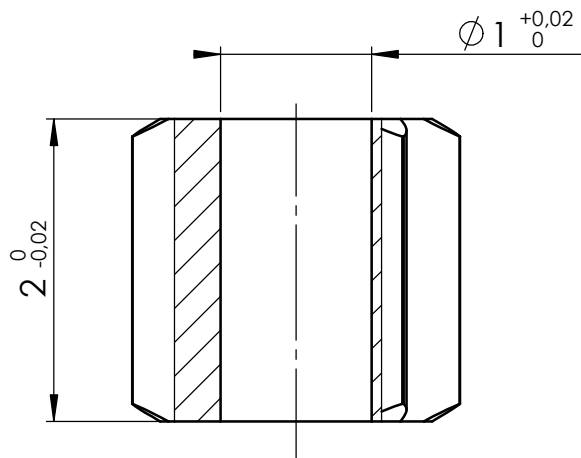

SOL-EXPERT

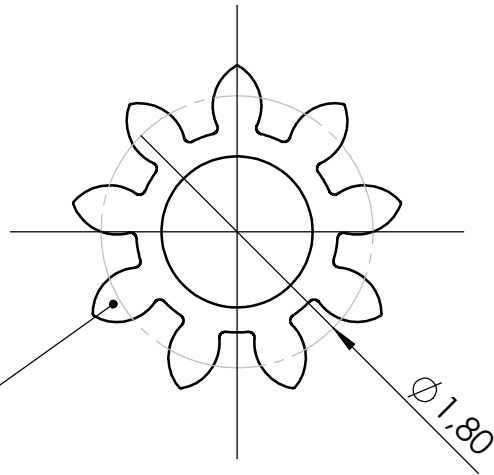
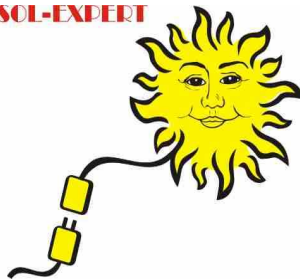

Erstellt durch / author
 SolExpert group

Material / material
 Messing / brass

Maßstab / scale
 20:1

Datum / date

06.02.2017

Benennung / description

Zahnrad / sprocket



Bestellnummer / order-no
 Z91

Blatt
 1/1

Rev.